

THIS DRAWING IS UNPUBLISHED. RELEASED FOR PUBLICATION, 19 .
 © COPYRIGHT 19 BY AMP INCORPORATED. ALL RIGHTS RESERVED.

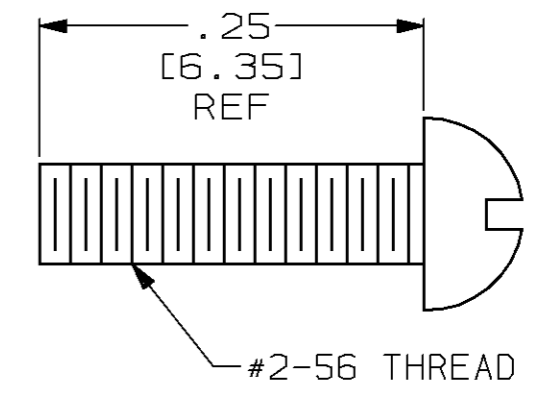

LOC	DIST	REVISIONS			
P	LTR	DESCRIPTION	DATE	DWN	APVD
DF	F0				
	C	REV PER 0600-2818-94	01-10-95	TT	DG
	D	REV PER 0600-4263-95	2-96	CT	DG

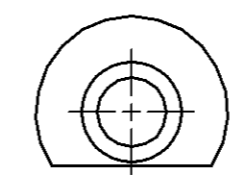

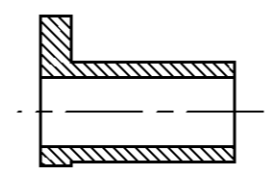
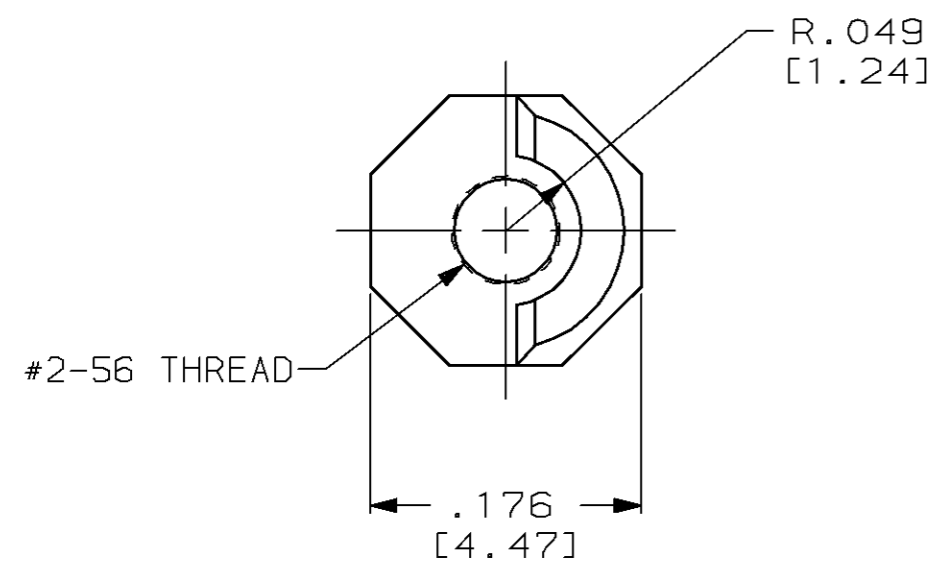

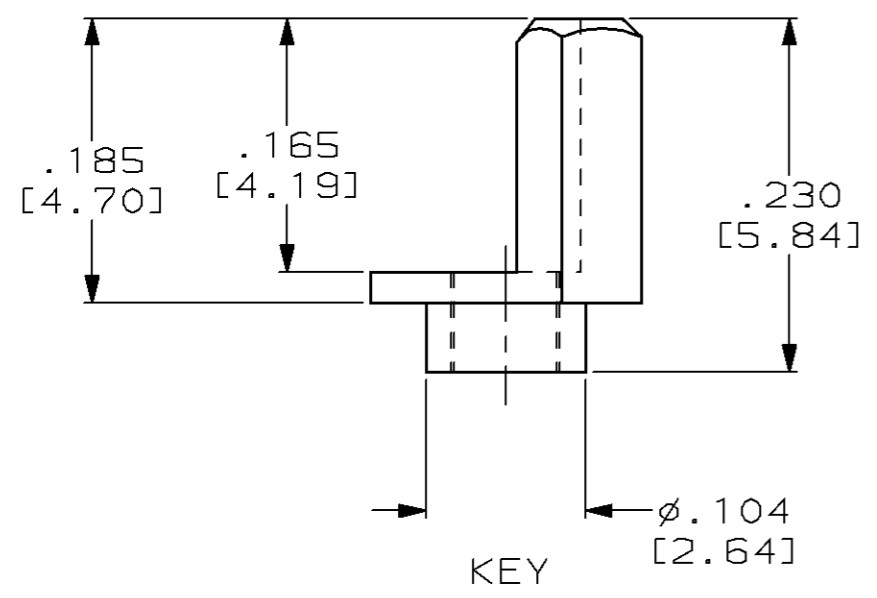
RIVET 

SCREW



1. KEY PRESS FITS INTO MINI-BOX PIN HEADER AND/OR RECEPTACLES USING TOOL #91117-2.
-  2. SCREWS ARE TO MOUNT KEYED RECEPTACLES TO P.C. BOARD.
-  3. RIVET IS CRIMPED INTO KEY WITH AMP TOOL #91117-6, RIVET TOOL MUST NOT BE USED IN PLACE OF PRESS FIT TOOL.
4. SEE "IS 7894" FOR KEY INSERTION.
-  5. REFER TO DRAWING 534164 FOR DETAIL DIMENSIONS.

	-	2	530721-1	2	534164-2	-	-	KIT	530721-4
	-	2	530721-1	-	-	2	7-21082-1	KIT	530721-3
NOT RELEASED	-	-	-	-	-	-	-	-	530721-2
AS SHOWN	M55302/31-06	1	530721-1	-	-	-	-	KEY	530721-1
REMARKS	MILITARY PART NO.	QTY	KEY	QTY	RIVET	QTY	#2-56 SCREW .25 LONG [6.35]	DESCRIPTION	PART NUMBER

THIS DRAWING IS A CONTROLLED DOCUMENT FOR AMP INCORPORATED. IT IS SUBJECT TO CHANGE AND THE CONTROLLING ENGINEERING ORGANIZATION SHOULD BE CONTACTED FOR THE LATEST REVISION.

DIMENSIONS:	TOLERANCES UNLESS OTHERWISE SPECIFIED:
INCHES [mm]	
	0 PLC ±-
	1 PLC ±-
	2 PLC ±-
	3 PLC ±.005 [0.13]
	4 PLC ±-
	ANGLES ±-
MATERIAL	FINISH
STAINLESS STEEL	PASSIVATED

DWN	T. THOMPSON	01-10-95
CHK	D. GUTTER	01-23-95
APVD	D. GUTTER	01-23-95
PRODUCT SPEC	-	-
APPLICATION SPEC	-	-
WEIGHT	-	-
CUSTOMER DRAWING		

AMP AMP Incorporated
Harrisburg, PA 17105-3608

NAME: EXTERNAL KEY, MINI-BOX, STANDARD

SIZE: A3 CAGE CODE: 00779 DRAWING NO: C-530721

SCALE: 8:1 SHEET: 1 OF 1 REV: D